

PDA100A - March 1, 2018

Item # PDA100A was discontinued on March 1, 2018. For informational purposes, this is a copy of the website content at that time and is valid only for the stated product.

SI FREE-SPACE AMPLIFIED PHOTODETECTORS

- ▶ Wavelength Ranges from 200 nm to 1100 nm
- ▶ Maximum Bandwidths up to 1.5 GHz
- ▶ Sensitivities Down to Femtowatt Powers
- ▶ Fixed and Switchable Gain Versions

Application Idea

PDA Series Detector with Ø1" Lens Tube Attached to a 30 mm Cage System



PDA10A2
Fixed Gain



PDA36A
Switchable Gain
10 MHz Max Bandwidth



FPD610-FS-VIS
Fixed Gain
600 MHz Max Bandwidth



[Hide Overview](#)

OVERVIEW

Features

- Wavelength Ranges within 200 to 1100 nm
- Low-Noise Amplification with Fixed or Switchable Gain
- Load Impedances 50 Ω and Higher for ≥5 kHz Bandwidth Versions
- Free-Space Optical Coupling

We offer a selection of Silicon (Si) Free-Space Amplified Photodetectors that are sensitive to light in the UV to the NIR wavelength range. Thorlabs' amplified photodetectors feature a built-in low-noise transimpedance amplifier (TIA) or a low-noise TIA followed by a voltage amplifier. Menlo Systems' FPD series amplified photodetectors have a built-in radio frequency (RF) or transimpedance amplifier. We offer fixed-gain versions that possess a fixed maximum bandwidth and total transimpedance gain, as well as switchable-gain versions with two or eight gain settings.

Thorlabs' photodetectors are designed to meet a range of requirements, with offerings that include the 380 MHz PDA015A with an impulse response of 1 ns, the high-sensitivity PDF10A with a noise equivalent power (NEP) of 1.4 fW/Hz^{1/2}, and the switchable-gain PDA100A with eight switchable maximum gain (bandwidth) combinations from 1.15 kV/A (2.4 MHz) to 4.75 MV/A (5.9 kHz). The PDF10A with femtowatt sensitivity is a low-frequency device that should only be terminated into high impedance (Hi-Z) loads, while all other of our silicon amplified photodetectors are capable of driving loads from 50 Ω to Hi-Z. Every detector has internal SM05 (0.535"-40) threading and external SM1 (1.035"-40) threading. Except for the PDA10A2, each unit's housing features 8-32 tapped holes (M4 for -EC and /M models). The PDA10A2 features a new housing with universal taps that accept both 8-32 and M4. For more information about the location of these mounting points and mounting these units, please see the *Housing Features* and *Mounting Options* tabs.

Item #	Wavelength Range	Bandwidth	NEP
Fixed Gain			
PDA10A2	200 - 1100 nm	DC - 150 MHz	29.2 pW/Hz ^{1/2}
PDA8A(/M)	320 - 1000 nm	DC - 50 MHz	6.5 pW/Hz ^{1/2}
PDF10A(/M)	320 - 1100 nm	DC - 20 Hz	1.4 x 10 ⁻³ pW/Hz ^{1/2}
PDA015A(/M)	400 - 1000 nm	DC - 380 MHz	36 pW/Hz ^{1/2}
FPD510-FV	400 - 1000 nm	DC - 250 MHz	6.0 pW/Hz ^{1/2}
FPD610-FS-VIS	400 - 1000 nm	DC - 600 MHz	11.2 pW/Hz ^{1/2}
Switchable Gain			
PDA100A(-EC) ^a	340 - 1100 nm	DC - 2.4 MHz	0.973 - 27 pW/Hz ^{1/2}
PDA36A(-EC) ^a	350 - 1000 nm	DC - 10 MHz	0.593 - 29.1 pW/Hz ^{1/2}
FPD310-FV ^b	400 - 1000 nm	1 - 1500 MHz	30.0 pW/Hz ^{1/2}

a. Switchable with 8 x 10 dB steps.

b. Switchable with 2 steps, 0 and 20 dB.



Click to Enlarge
The PDA36A with the Included ± 12 V Power Supply.
Replacement power supplies are sold below.

Menlo Systems' FPD series detectors are easy-to-use photodiode packages with an integrated high-gain, low-noise RF (FPD310-FV) or transimpedance (FPD510-FV and FPD610-FS-VIS) amplifier. The FPD310-FV is ideal for experiments requiring high bandwidths and extremely short rise times (< 1 ns). This detector has a switchable gain with two steps, 0 and 20 dB. The FPD510-FV and FPD610-FS-VIS have a fixed gain and are optimized for the highest signal-to-noise ratio when detecting low-level optical beat signals at frequencies up to 250 MHz and 600 MHz, respectively. The FPD510-FV has a rise time of 2 ns, while the FPD610-FS-VIS has a 1 ns rise time. The 3 dB bandwidth of these DC-coupled devices is 200 MHz for the FPD510-FV and 500 MHz for the FPD610-FS-VIS. The compact design of the FPD detectors allows for easy OEM integration. The housing of each Menlo detector features one M4 tapped hole for post mounting. For more information about the housing, please see the *Housing Features* tab. For versions of these detectors with FC/PC inputs, see Si Fiber-Coupled Amplified Detectors.



Click to Enlarge
Menlo Systems' FPD610-FS-VIS Includes a Location-Specific ± 12 V Power Supply

Power Supply

A ± 12 V linear power supply is included with each amplified photodetector. A power supply that supports input voltages of 100, 120, and 230 VAC and is compatible with these detectors is also available separately below. Before connecting the power supply to the mains, ensure that the line voltage switch on the power supply module is set to the proper voltage range (either 115 or 230 VAC for all detectors except the PDA10A2). The power supply included with the PDA10A2 features a three-way switch and can be plugged into any 50 to 60Hz, 100 V / 120 V / 230 V power outlet. The power supplies should always be powered up using the power switch on the power supply itself. Hot plugging the unit is not recommended.

Menlo's FPD610-FS-VIS includes a low-noise power supply, while the FPD310-FV and FPD510-FV do not come with a power supply. These two detectors require a customer-supplied power supply between +8 and +20 VDC. For best performance, we recommend using a linear regulated power supply or a battery. Thorlabs' LDS9 is a suitable power supply that can be wired by the customer to operate these detectors. As can be seen in the drawings for these detectors, a pin and ground are provided for soldering a power supply to the detector. When connecting a power supply, please note the polarity of the supply. A switched power supply is not recommended as it may introduce switching noise in the output signal.

[Hide Specs](#)

S P E C S

Performance Specifications

Item #	Wavelength	Bandwidth	Rise Time	Peak Responsivity	Noise Equivalent Power (NEP) ^a	Active Area	Operating Temperature Range
Fixed Gain							
PDA10A2 ^b	200 - 1100 nm ^c	DC - 150 MHz	2.3 ns	0.44 A/W @ 730 nm	29.2 pW/Hz ^{1/2}	0.8 mm ² (Ø1 mm)	10 to 50 °C
PDA8A ^b	320 - 1000 nm	DC - 50 MHz	7 ns	0.56 A/W @ 820 nm	6.5 pW/Hz ^{1/2}	0.5 mm ² (Ø0.8 mm)	10 to 50 °C
PDF10A	320 - 1100 nm	DC - 20 Hz	22 ms	0.6 A/W @ 960 nm	1.4x10 ⁻³ pW/Hz ^{1/2}	1.2 mm ² (1.1 mm x 1.1 mm)	18 to 28 °C
PDA015A ^b	400 - 1000 nm	DC - 380 MHz	1.0 ns	0.47 A/W @ 740 nm	36 pW/Hz ^{1/2}	0.018 mm ² (Ø150 µm)	10 to 40 °C
FPD510-FV	400 - 1000 nm	DC - 250 MHz	2 ns	-	6.0 pW/Hz ^{1/2}	0.13 mm ² (Ø0.4 mm)	10 to 40 °C
FPD610-FS-VIS	400 - 1000 nm	DC - 600 MHz	1 ns	-	11.2 pW/Hz ^{1/2}	0.13 mm ² (Ø0.4 mm)	10 to 40 °C
Switchable Gain							
PDA100A	340 - 1100 nm	DC - 2.4 MHz ^d	N/A ^e	0.62 A/W @ 960 nm	0.973 - 27 pW/Hz ^{1/2}	100 mm ² (10 mm x 10 mm)	10 to 40 °C
PDA36A	350 - 1100 nm	DC - 10 MHz ^d	N/A ^e	0.65 A/W @ 970 nm	0.593 - 29.1 pW/Hz ^{1/2}	13 mm ² (3.6 mm x 3.6 mm)	0 to 40 °C
FPD310-FV	400 - 1000 nm	1 - 1500 MHz	0.7 ns	-	30.0 pW/Hz ^{1/2}	0.13 mm ² (Ø0.4 mm)	10 to 40 °C

- NEP is specified at the peak responsivity wavelength. As NEP changes with the gain setting for the switchable-gain versions, an NEP range is given for these.
- This detector has a 50 Ω terminator resistor that is in series with the amplifier output. This forms a voltage divider with any load impedance (e.g. 50 Ω load divides signal in half).
- When long-term UV light is applied, the product specifications may degrade. For example, the product's UV response may decrease and the dark current may increase. The degree to which the specifications may degrade is based upon factors such as the irradiation level, intensity, and usage time.
- This is the maximum possible bandwidth for these amplified photodetectors. Bandwidth varies as a function of gain. For more information see the *Switchable Gain* table below.
- Rise times depend on the chosen gain level and wavelength. As one increases the gain of a given optical amplifier, the bandwidth is reduced, and

hence, the rise time increases. Please refer to the photodiode tutorial for information on calculating the rise time. Bandwidth specifications for each switchable photodetector may be found in the table below.

Gain Specifications

Fixed Gain

Item #	Gain w/ Hi-Z Load	Gain w/ 50 Ω Load	Offset (\pm)	Output Voltage w/ Hi-Z Load	Output Voltage w/ 50 Ω Load
PDA10A2	10 kV/A	5 kV/A	10 mV	0 - 10 V	0 - 5 V
PDA8A	100 kV/A	50 kV/A	10 mV (Max)	0 - 3.6 V	0 - 1.8 V
PDF10A ^a	1x10 ⁹ kV/A	-	<150 mV	0 - 10 V	-
PDA015A	50 kV/A	25 kV/A	20 mV	0 - 10 V	0 - 5 V
FPD510-FV	-	4 x 10 ⁴ V/W	-	-	0 - 1 V
FPD610-FS-VIS	-	2 x 10 ⁶ V/W	-	-	0 - 1 V

a. Due to its 25 Hz cutoff frequency, operating the PDF10C(M) with less than high impedance loading is not recommended.

Switchable Gain

Item #	Gain Step (dB)	Gain w/ Hi-Z Load ^a	Gain w/ 50 Ω Load ^a	Bandwidth	Noise (RMS)	NEP ^b	Offset (\pm)	Output Voltage w/ Hi-Z Load	Output Voltage w/ 50 Ω Load
PDA100A	0	1.51 kV/A	0.75 kV/A	2.4 MHz	254 μ V	27 pW/Hz ^{1/2}	5 mV (10 mV Max)	0 - 10 V	0 - 5 V
	10	4.75 kV/A	2.38 kV/A	1.6 MHz	261 μ V	11 pW/Hz ^{1/2}	6 mV (12 mV Max)		
	20	15 kV/A	7.5 kV/A	860 kHz	349 μ V	8.91 pW/Hz ^{1/2}	6 mV (15 mV Max)		
	30	47.5 kV/A	23.8 kV/A	480 kHz	561 μ V	4.65 pW/Hz ^{1/2}	8 mV (15 mV Max)		
	40	150 kV/A	75 kV/A	225 kHz	799 μ V	3.55 pW/Hz ^{1/2}	8 mV (15 mV Max)		
	50	475 kV/A	238 kV/A	78 kHz	998 μ V	2.42 pW/Hz ^{1/2}	8 mV (15 mV Max)		
	60	1.5 MV/A	750 kV/A	20 kHz	1163 μ V	1.22 pW/Hz ^{1/2}	8 mV (15 mV Max)		
	70	4.75 MV/A	2.38 MV/A	5.9 kHz	1490 μ V	0.973 pW/Hz ^{1/2}	30 mV		
PDA36A	0	1.51 kV/A	0.75 kV/A	10.0 MHz	300 μ V	29.1 pW/Hz ^{1/2}	3 mV (10 mV Max)	0 - 10 V	0 - 5 V
	10	4.75 kV/A	2.38 kV/A	5.5 MHz	280 μ V	7.52 pW/Hz ^{1/2}	4 mV (10 mV Max)		
	20	15 kV/A	7.5 kV/A	1.0 MHz	250 μ V	2.34 pW/Hz ^{1/2}	4 mV (10 mV Max)		
	30	47.5 kV/A	23.8 kV/A	260 kHz	260 μ V	1.21 pW/Hz ^{1/2}	4 mV (10 mV Max)		
	40	150 kV/A	75 kV/A	150 kHz	340 μ V	0.593 pW/Hz ^{1/2}	4 mV (10 mV Max)		
	50	475 kV/A	238 kV/A	45 kHz	400 μ V	0.794 pW/Hz ^{1/2}	4 mV (10 mV Max)		
	60	1.5 MV/A	750 kV/A	11 kHz	800 μ V	1.43 pW/Hz ^{1/2}	5 mV (10 mV Max)		
	70	4.75 MV/A	2.38 MV/A	5 kHz	1.10 mV	2.10 pW/Hz ^{1/2}	6 mV (10 mV Max)		
FPD310-FV	0	-	5 x 10 ⁴ V/W	10 - 1000 MHz	- ^c	30.0 pW/Hz ^{1/2}	N/A (AC Coupling)	-	~1 V
	20	-	5 x 10 ² V/W					-	~100 mV

- a. Gain figures can also be expressed in units of Ω .
 b. The Noise Equivalent Power is specified at the peak wavelength.
 c. The Dark State Noise Level is -90 dBm.

[Hide Housing Features](#)

HOUSING FEATURES

Housing Features of the Amplified Si Photodetectors

PDA and PDF Detectors

Thorlabs' Amplified Photodiode series feature a slim design and many common elements. Each housing features internal SM05 (0.535"-40) threading and external SM1 (1.035"-40) threading. All detectors include an SM1T1 internally SM1-threaded adapter. Most SM1-threaded fiber adapters are compatible with these detectors. The PDA015A, PDA10A2, PDA36A, and PDA100A also each include an





Click to Enlarge
Top of the housing on our PDA and PDF detector housings. The Power In connector, Output BNC connector, and power indicator LED are located at the top of the housing. The PDA015A detector is shown.

Click to Enlarge
The housings of Thorlabs' detectors feature internal SM05 and external SM1 threads. An SM1T1 SM1 Adapter with internal threads is included with each amplified photodetector, and an SM1RR Retaining Ring is included with the PDA015A, PDA10A2, PDA36A, and PDA100A.

SM1RR retaining ring. A TRE(TRE/M) electrically isolated Ø1/2" post adapter is included with the PDF10A.

Threaded holes on the housings of the detectors allow the units to be mounted in a horizontal or vertical orientation, which gives the user the option to route the power and BNC cables from above or alongside the beam path. The PDA015A, PDA36A, and PDA100A have two 8-32 threaded holes, while their metric counterparts have two M4 threaded holes. The PDA8A and PDF10A have three 8-32 threaded holes, while their metric counterparts have three M4 threaded holes. The PDA10A2 has a new housing design that features the active area flush with the front of the housing, simplifying alignments within optomechanical systems. This detector also has two universal threaded holes compatible with both 8-32 and M4 threads (please refer to the table below). As a convenience, the back panels of the PDA10A2 and PDA015A are engraved with the responsivity curve of the Si photodiodes. For more information on mounting these units, please see the *Mounting Options* tab.

FPD Detectors

The housing of each Menlo Systems' FPD detector features one M4 tapped hole on the bottom for post mounting. The FPD310-FV and FPD510-FV housings also have two Ø0.2" (Ø5 mm) mounting holes on the front face of the the detector. The power supply connector and output SMA connector are located on the side of the housing.

Detectors	Housing Drawing (Click Icon for Details)	Mounting Taps	SM Thread Compatibility	Dimensions	Output Connector
PDA/PDF Fixed Gain					
PDA10A2		Two Universal Taps for 8-32 and M4	Internal SM05 (0.535"-40) External SM1 (1.035"-40)	49.8 mm x 22.5 mm x 70.9 mm (1.96" x 0.89" x 2.79")	BNC
PDA015A		Two 8-32 Taps (M4 for Metric Version)		48.0 mm x 21.1 mm x 70.2 mm (1.89" x 0.83" x 2.76")	
PDA8A, PDF10A		Three 8-32 Taps (M4 for Metric Version)		43.2 mm x 21.1 mm x 65.3 mm (1.70" x 0.83" x 2.57")	
FPD Fixed Gain					
FPD510-FV		One M4 Tap; Two Ø0.2" (Ø5 mm) Holes	N/A	60.0 mm x 26.5 mm x 50.0 mm (2.36" x 1.04" x 1.97")	SMA
FPD610-FS-VIS		One M4 Tap	N/A	60.0 mm x 20.0 mm x 50.0 mm (2.36" x 0.79" x 1.97")	
PDA Switchable Gain					
PDA36A, PDA100A		Two 8-32 Taps (M4 for Metric Version)	Internal SM05 (0.535"-40) External SM1 (1.035"-40)	52.3 mm x 22.4 mm x 70.1 mm (2.06" x 0.88" x 2.76")	BNC
FPD Switchable Gain					
FPD310-FV		One M4 Tap; Two Ø0.2" (Ø5 mm) Holes	N/A	60.0 mm x 26.5 mm x 50.0 mm (2.36" x 1.04" x 1.97")	SMA

[Hide Mounting Options](#)

MOUNTING OPTIONS

PDA and PDF Series Mounting Options

The PDA series of amplified photodetectors are compatible with our entire line of lens tubes, TR series posts, and cage mounting systems. Because of the wide range of mounting options, the best method for mounting the housing in a given optical setup is not always obvious. The pictures and text in this tab will discuss some of the common mounting solutions. As always, our technical support staff is available for individual consultation.

--	--	--



Picture of a PDA series photodetector as it will look when unpackaged.



Picture of a DET series photodetector with the included SM1T1 and its retaining ring removed from the front of the housing. Thorlabs' PDA series photodetectors feature the same mounting options.



A close up picture of the front of the PDA10A photodetector. The internal SM1 threading on the SM1T1 adapter and internal SM05 threading on the photodetector housing can be seen in this image.

TR Series Post (Ø1/2" Posts) System

The PDA housing can be mounted vertically or horizontally on a TR Series Post using the 8-32 (M4 on metric versions) threaded holes. Select PDA housings feature universally threaded holes for both 8-32 and M4 threads.



DET series photodetector mounted vertically on a TR series post. In this configuration, the output and power cables (PDA series) are oriented vertically and away from the optic table, facilitating a neater optical setup.



PDA series photodetector mounted horizontally on a TR series post. In this configuration, the on/off switch is conveniently oriented on the top of the detector.

Lens Tube System

Each PDA housing includes a detachable Ø1" Optic Mount (SM1T1) that allows for Ø1" (Ø25.4 mm) optical components, such as optical filters and lenses, to be mounted along the axis perpendicular to the center of the photosensitive region. The maximum thickness of an optic that can be mounted in the SM1T1 is 0.1" (2.8 mm). For thicker Ø1" (Ø25.4 mm) optics or for any thickness of Ø0.5" (Ø12.7 mm) optics, remove the SM1T1 from the front of the detector and place (must be purchased separately) an SM1 or SM05 series lens tube, respectively, on the front of the detector.

The SM1 and SM05 threadings on the PDA photodetector housing make it compatible with our SM lens tube system and accessories. Two particularly useful accessories include the SM-threaded irises and the SM-compatible IR and visible alignment tools. Also available are fiber optic adapters for use with connectorized fibers.



DET series photodetector mounted onto an SM1L30C Ø1" Slotted Lens Tube, which is housing a focusing optic. The lens tube is attached to a 30 mm cage system via a CP02 SM1-Threaded 30 mm Cage Plate. This arrangement allows easy access for optic adjustment and signal alignment.

Cage System

The simplest method for attaching the PDA photodetector housing to a cage plate is to remove the SM1T1 that is attached to the front of the PDA when it is shipped. This will expose external SM1 threading that is deep enough to thread the photodetector directly to a CP02 30 mm cage plate. When the CP02 cage plate is tightened down onto the PDA photodetector housing, the cage plate will not necessarily be square with the detector. To fix this, back off the cage plate until it is square with the photodetector and then use the retaining ring included with the SM1T1 to lock the PDA photodetector into the desired location.

This method for attaching the PDA photodetector housing to a cage plate does not allow much freedom in determining the orientation of the photodetector; however, it has the benefit of not needing an adapter piece, and it allows the diode to be as close as possible to the cage plate, which can be important in setups where the light is divergent. As a side note, Thorlabs sells the SM05PD and SM1PD series of photodiodes that can be threaded into a cage plate so that the diode is flush with the front surface of the cage plate; however, the photodiode is unbiased.

For more freedom in choosing the orientation of the PDA photodetector housing when attaching it, a SM1T2 lens tube coupler can be purchased. In this configuration the SM1T1 is left on the detector and the SM1T2 is threaded into it. The exposed external SM1 threading is now deep enough to secure the detector to a CP02 cage plate in any orientation and lock it into place using one of the two locking rings on the ST1T2.



These two pictures show a DET series photodetector in a horizontal

This picture shows a DET series photodetector attached to a CP02 cage plate after removing the SM1T1. The retaining ring from the SM1T1 was used to make the orientation of the detector square with the cage plate.

configuration. The top picture shows the detector directly coupled to a CP02 cage plate.
The bottom picture shows a DET series photodetector attached to a CP02 cage plate using an SM1T2 adapter in addition to the SM1T1 that comes with the PDA series detector.

Although not pictured here, the PDA photodetector housing can be connected to a 16 mm cage system by purchasing an SM05T2. It can be used to connect the PDA photodetector housing to an SP02 cage plate.

Application

The image below shows a Michelson Interferometer built entirely from parts available from Thorlabs. This application demonstrates the ease with which an optical system can be constructed using our lens tube, TR series post, and cage systems. A PDA series photodetector is interchangeable with the DET series photodetector shown in the picture.

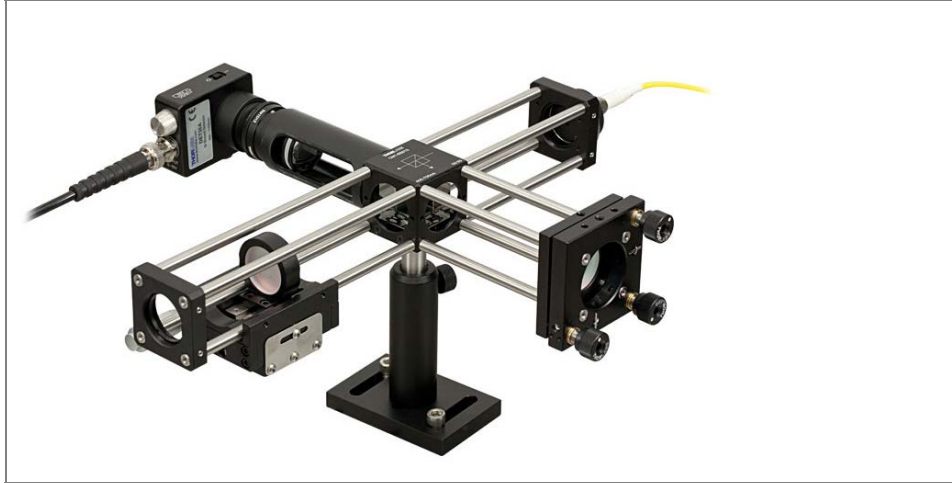

The table below contains a part list for the Michelson Interferometer for use in the visible range. Follow the links to the pages for more information about the individual parts.

Item #	Quantity	Description	Item #	Quantity	Description
KC1	1	Mirror Mount	CT1	1	1/2" Travel Translator
BB1-E02	2	Broadband Dielectric Laser Mirrors	SM1D12	1	SM1 Threaded Lens Tube Iris
ER4	8	4" Cage Rods	SM1L30C	1	SM1 3" Slotted Lens Tube
ER6	4	6" Cage Rods	SM1V05	1	Ø1" Adjustable Length Lens Tube
CCM1-BS013	1	Cube-Mounted Beamsplitter	CP08FP	1	30 mm Cage Plate for FiberPorts
BA2	1	Post Base (not shown in picture)	PAF-X-5-A	1	FiberPort
TR2	1	Ø1/2" Post, 2" in Length	P1-460B-FC-2	1	Single Mode Fiber Patch Cable
PH2	1	Ø1/2" Post Holder	DET36A / PDA36A	1	Biased / Amplified Photodiode Detector

[Hide Pin Diagrams](#)

PIN DIAGRAMS

PDA and PDF Series Detectors

BNC Female Output (Photodetector)

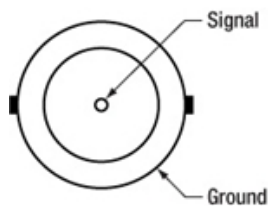

PDA10A2, PDF10A, PDA015A, PDA100A, PDA36A: 0 - 10 V Output
PDA8A: 0 - 3.6 V Output

Male (Power Cables)



Female Power IN (Photodetector)

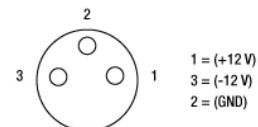

Signal Out- SMA Female
(Photodetector)

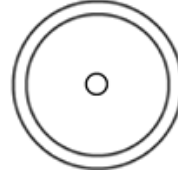

For connection to a suitable monitoring device, e.g. oscilloscope or RF-spectrum-analyzer, with 50 Ω impedance.

FPD610-FS-VIS

Signal Out- SMA Female
(Photodetector)

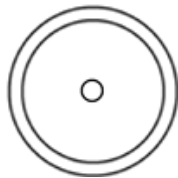

For connection to a suitable monitoring device, e.g. oscilloscope or RF-spectrum-analyzer, with 50 Ω impedance.

Female (Power Cables)

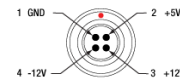

Male Power IN (Photodetector)

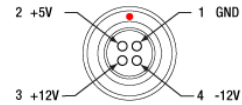

[Hide Photodiode Tutorial](#)

PHOTODIODE TUTORIAL

Photodiode Tutorial
Theory of Operation

A junction photodiode is an intrinsic device that behaves similarly to an ordinary signal diode, but it generates a photocurrent when light is absorbed in the depleted region of the junction semiconductor. A photodiode is a fast, highly linear device that exhibits high quantum efficiency based upon the application and may be used in a variety of different applications.

It is necessary to be able to correctly determine the level of the output current to expect and the responsivity based upon the incident light. Depicted in Figure 1 is a junction photodiode model with basic discrete components to help visualize the main characteristics and gain a better understanding of the operation of Thorlabs' photodiodes.

$$I_{OUT} = I_{DARK} + I_{PD}$$

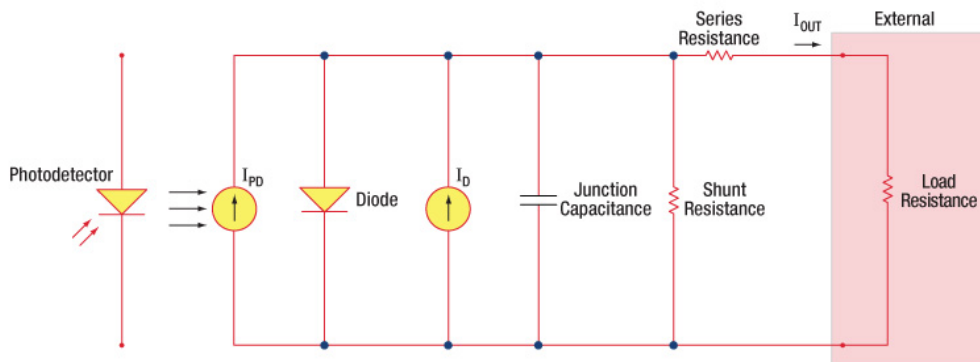

Figure 1: Photodiode Model

Photodiode Terminology

Responsivity

The responsivity of a photodiode can be defined as a ratio of generated photocurrent (I_{PD}) to the incident light power (P) at a given wavelength:

$$R(\lambda) = \frac{I_{PD}}{P}$$

Modes of Operation (Photoconductive vs. Photovoltaic)

A photodiode can be operated in one of two modes: photoconductive (reverse bias) or photovoltaic (zero-bias). Mode selection depends upon the application's speed requirements and the amount of tolerable dark current (leakage current).

Photoconductive

In photoconductive mode, an external reverse bias is applied, which is the basis for our DET series detectors. The current measured through the circuit indicates illumination of the device; the measured output current is linearly proportional to the input optical power. Applying a reverse bias increases the width of the depletion junction producing an increased responsivity with a decrease in junction capacitance and produces a very linear response. Operating under these conditions does tend to produce a larger dark current, but this can be limited based upon the photodiode material. (Note: Our DET detectors are reverse biased and cannot be operated under a forward bias.)

Photovoltaic

In photovoltaic mode the photodiode is zero biased. The flow of current out of the device is restricted and a voltage builds up. This mode of operation exploits the photovoltaic effect, which is the basis for solar cells. The amount of dark current is kept at a minimum when operating in photovoltaic mode.

Dark Current

Dark current is leakage current that flows when a bias voltage is applied to a photodiode. When operating in a photoconductive mode, there tends to be a higher dark current that varies directly with temperature. Dark current approximately doubles for every 10 °C increase in temperature, and shunt resistance tends to double for every 6 °C rise. Of course, applying a higher bias will decrease the junction capacitance but will increase the amount of dark current present.

The dark current present is also affected by the photodiode material and the size of the active area. Silicon devices generally produce low dark current compared to germanium devices which have high dark currents. The table below lists several photodiode materials and their relative dark currents, speeds, sensitivity, and costs.

Material	Dark Current	Speed	Spectral Range	Cost
Silicon (Si)	Low	High Speed	Visible to NIR	Low
Germanium (Ge)	High	Low Speed	NIR	Low
Gallium Phosphide (GaP)	Low	High Speed	UV to Visible	Moderate
Indium Gallium Arsenide (InGaAs)	Low	High Speed	NIR	Moderate
Indium Arsenide Antimonide (InAsSb)	High	Low Speed	NIR to MIR	High
Extended Range Indium Gallium Arsenide (InGaAs)	High	High Speed	NIR	High
Mercury Cadmium Telluride (MCT, HgCdTe)	High	Low Speed	NIR to MIR	High

Junction Capacitance

Junction capacitance (C_j) is an important property of a photodiode as this can have a profound impact on the photodiode's bandwidth and response. It should be noted that larger diode areas encompass a greater junction volume with increased charge capacity. In a reverse bias application, the depletion width of the junction is increased, thus effectively reducing the junction capacitance and increasing the response speed.

Bandwidth and Response

A load resistor will react with the photodetector junction capacitance to limit the bandwidth. For best frequency response, a 50 Ω terminator should be used in conjunction with a 50 Ω coaxial cable. The bandwidth (f_{BW}) and the rise time response (t_r) can be approximated using the junction capacitance (C_j) and the load resistance (R_{LOAD}):

$$f_{BW} = 1 / (2 * \pi * R_{LOAD} * C_j)$$
$$t_r = 0.35 / f_{BW}$$

Noise Equivalent Power

The noise equivalent power (NEP) is the generated RMS signal voltage generated when the signal to noise ratio is equal to one. This is useful, as the NEP determines the ability of the detector to detect low level light. In general, the NEP increases with the active area of the detector and is given by the following equation:

$$NEP = \frac{\text{Incident Energy} * \text{Area}}{\frac{S}{N} * \sqrt{\Delta f}}$$

Here, S/N is the Signal to Noise Ratio, Δf is the Noise Bandwidth, and Incident Energy has units of W/cm^2 . For more information on NEP, please see Thorlabs' Noise Equivalent Power White Paper.

Terminating Resistance

A load resistance is used to convert the generated photocurrent into a voltage (V_{OUT}) for viewing on an oscilloscope:

$$V_{OUT} = I_{OUT} * R_{LOAD}$$

Depending on the type of the photodiode, load resistance can affect the response speed. For maximum bandwidth, we recommend using a 50 Ω coaxial cable with a 50 Ω terminating resistor at the opposite end of the cable. This will minimize ringing by matching the cable with its characteristic impedance. If bandwidth is not important, you may increase the amount of voltage for a given light level by increasing R_{LOAD} . In an unmatched termination, the length of the coaxial cable can have a profound impact on the response, so it is recommended to keep the cable as short as possible.

Shunt Resistance

Shunt resistance represents the resistance of the zero-biased photodiode junction. An ideal photodiode will have an infinite shunt resistance, but actual values may range from the order of ten Ω to thousands of $M\Omega$ and is dependent on the photodiode material. For example, and InGaAs detector has a shunt resistance on the order of 10 $M\Omega$ while a Ge detector is in the $k\Omega$ range. This can significantly impact the noise current on the photodiode. For most applications, however, the high resistance produces little effect and can be ignored.

Series Resistance

Series resistance is the resistance of the semiconductor material, and this low resistance can generally be ignored. The series resistance arises from the contacts and the wire bonds of the photodiode and is used to mainly determine the linearity of the photodiode under zero bias conditions.

Common Operating Circuits

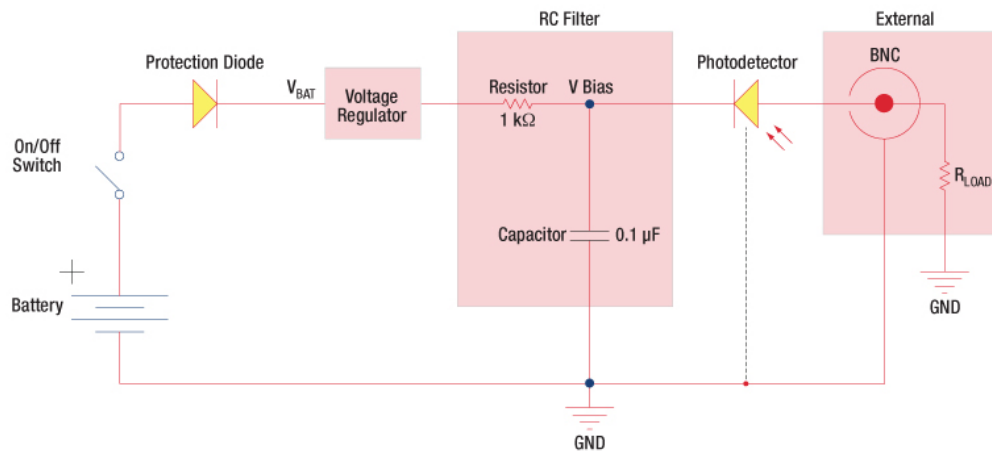

Figure 2: Reverse-Biased Circuit (DET Series Detectors)

The DET series detectors are modeled with the circuit depicted above. The detector is reverse biased to produce a linear response to the applied input light. The amount of photocurrent generated is based upon the incident light and wavelength and can be viewed on an oscilloscope by attaching a load resistance on the output. The function of the RC filter is to filter any high-frequency noise from the input supply that may contribute to a noisy output.

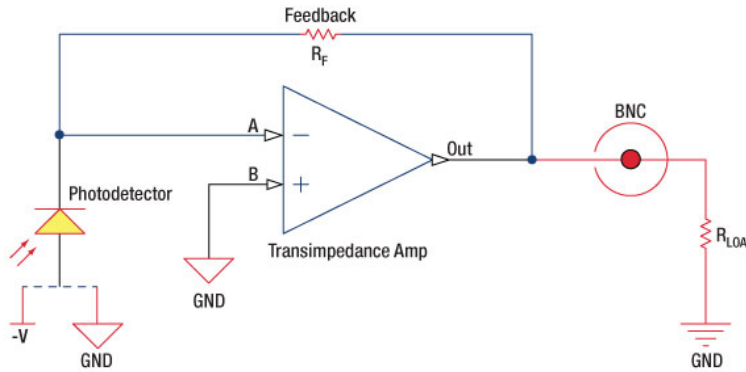

Figure 3: Amplified Detector Circuit

One can also use a photodiode with an amplifier for the purpose of achieving high gain. The user can choose whether to operate in Photovoltaic or Photoconductive modes. There are a few benefits of choosing this active circuit:

- Photovoltaic mode: The circuit is held at zero volts across the photodiode, since point A is held at the same potential as point B by the operational amplifier. This eliminates the possibility of dark current.
- Photoconductive mode: The photodiode is reversed biased, thus improving the bandwidth while lowering the junction capacitance. The gain of the detector is dependent on the feedback element (R_f). The bandwidth of the detector can be calculated using the following:

$$f(-3dB) = \sqrt{\frac{GBP}{4\pi * R_f * C_D}}$$

where GBP is the amplifier gain bandwidth product and C_D is the sum of the junction capacitance and amplifier capacitance.

Effects of Chopping Frequency

The photoconductor signal will remain constant up to the time constant response limit. Many detectors, including PbS, PbSe, HgCdTe (MCT), and InAsSb, have a typical $1/f$ noise spectrum (i.e., the noise decreases as chopping frequency increases), which has a profound impact on the time constant at lower frequencies.

The detector will exhibit lower responsivity at lower chopping frequencies. Frequency response and detectivity are maximized for

$$f_c = \frac{1}{2\pi\tau_r}$$

[Hide Cross Reference](#)

CROSS REFERENCE

The following table lists Thorlabs' selection of photodiodes and photoconductive detectors. Item numbers in the same row contain the same detector element.

Photodiode Cross Reference						
Wavelength	Material	Unmounted Photodiode	Unmounted Photoconductor	Mounted Photodiode	Biased Detector	Amplified Detector
150 - 550 nm	GaP	FGAP71	-	SM05PD7A	DET25K(/M)	PDA25K(-EC)
200 - 1100 nm	Si	FDS010	-	SM05PD2A SM05PD2B	DET10A2	PDA10A2
	Si	-	-	SM1PD2A	-	-
320 - 1100 nm	Si	-	-	-	-	PDA8A(/M)

	Si	FD11A	-	SM05PD3A	-	PDF10A(/M)
340 - 1100 nm	Si	-	-	-	-	PDA100A(-EC)
	Si	FDS10X10	-	-	-	-
350 - 1100 nm	Si	FDS100 FDS100-CAL ^a	-	SM05PD1A SM05PD1B	DET36A(/M)	PDA36A(-EC)
	Si	FDS1010 FDS1010-CAL ^a	-	SM1PD1A SM1PD1B	DET100A(/M)	
400 - 1000 nm	Si	-	-	-	-	PDA015A(/M) FPD510-FV FPD310-FV FPD310-FC-VIS FPD510-FC-VIS FPD610-FC-VIS FPD610-FS-VIS
400 - 1100 nm	Si	FDS015 ^b	-	-	-	-
	Si	FDS025 ^b FDS02 ^c	-	-	DET02AFC(/M) DET025AFC(/M) DET025A(/M) DET025AL(/M)	-
400 - 1700 nm	Si & InGaAs	DSD2	-	-	-	-
500 - 1700 nm	InGaAs	-	-	-	DET10N2	-
750 - 1650 nm	InGaAs	-	-	-	-	PDA8GS
800 - 1700 nm	InGaAs	FGA015	-	-	-	PDA015C(/M)
	InGaAs	FGA21 FGA21-CAL ^a	-	SM05PD5A	DET20C(/M)	PDA20C(/M) PDA20CS(-EC)
	InGaAs	FGA01 ^b FGA01FC ^c	-	-	DET01CFC(/M)	-
	InGaAs	FDGA05 ^b	-	-	-	PDA05CF2
	InGaAs	-	-	-	DET08CFC(/M) DET08C(/M) DET08CL(/M)	PDF10C(/M)
800 - 1800 nm	Ge	FDG03 FDG03-CAL ^a	-	SM05PD6A	DET30B2	PDA30B2
	Ge	FDG50	-	-	DET50B2	PDA50B(-EC)
	Ge	FDG05	-	-	-	-
800 - 2600 nm	InGaAs	-	-	-	DET05D(/M)	-
850 - 1650 nm	InGaAs	-	-	-	-	FPD510-F
900 - 1700 nm	InGaAs	FGA10	-	SM05PD4A	DET10C(/M)	PDA10CS(-EC)
900 - 2600 nm	InGaAs	FD05D	-	-	-	-
		FD10D	-	-	-	-
		-	-	-	DET10D2	-
950 - 1650 nm	InGaAs	-	-	-	-	FPD310-FC-NIR FPD310-FS-NIR FPD510-FC-NIR FPD610-FC-NIR FPD610-FS-NIR
1.0 - 2.9 μ m	PbS	-	FDPS3X3	-	-	PDA30G(-EC)
1.0 - 5.8 μ m	InAsSb	-	-	-	-	PDA10PT(-EC)
1.2 - 2.6 μ m	InGaAs	-	-	-	-	PDA10D(-EC)
1.5 - 4.8 μ m	PbSe	-	FDPSE2X2	-	-	PDA20H(-EC)
2.0 - 5.4 μ m	HgCdTe (MCT)	-	-	-	-	PDA10JT(-EC)
2.0 - 8.0 μ m	HgCdTe (MCT)	VML8T0 VML8T4 ^d	-	-	-	PDAVJ8
2.0 - 10.6 μ m	HgCdTe (MCT)	VML10T0 VML10T4 ^d	-	-	-	PDAVJ10
2.7 - 5.0 μ m	HgCdTe (MCT)	VL5T0	-	-	-	-

a. Calibrated Unmounted Photodiode

- b. Unmounted TO-46 Can Photodiode
- c. Unmounted TO-46 Can Photodiode with FC/PC Bulkhead
- d. Photovoltaic Detector with Thermoelectric Cooler

[Hide Si Amplified Photodetectors, Fixed Gain](#)

Si Amplified Photodetectors, Fixed Gain







Item # ^a	Housing Features ^b	Wavelength Range	Bandwidth Range	Rise Time	Gain		NEP	Typical Performance Graphs	Active Area ^c	Operating Temperature Range	Power Supply Included
					Hi-Z Load	50 Ω Load					
PDA10A2		200 - 1100 nm ^d	DC - 150 MHz	2.3 ns	10 kV/A	5 kV/A	29.2 pW/Hz ^{1/2}		0.8 mm ² (Ø1 mm) ^e	10 to 50 °C	Yes
PDA8A		320 - 1000 nm	DC - 50 MHz	7 ns	100 kV/A	50 kV/A	6.5 pW/Hz ^{1/2}		0.5 mm ² (Ø0.8 mm)	10 to 50 °C	Yes
PDF10A		320 - 1100 nm	DC - 20 Hz	22 ms	1 x 10 ⁹ kV/A	-	1.4 x 10 ⁻³ pW/Hz ^{1/2}		1.2 mm ² (1.1 x 1.1 mm)	18 to 28 °C	Yes
PDA015A		400 - 1000 nm	DC - 380 MHz	1.0 ns	50 kV/A	25 kV/A	36 pW/Hz ^{1/2}		0.018 mm ² (Ø150 μm)	10 to 40 °C	Yes
FPD510-FV		400 - 1000 nm	DC - 250 MHz	2 ns	-	4 x 10 ⁴ V/W	6.0 pW/Hz ^{1/2}		0.13 mm ² (Ø0.4 mm)	10 to 40 °C	No ^f
FPD610-FS-VIS		400 - 1000 nm	DC - 600 MHz	1 ns	-	2 x 10 ⁶ V/W	11.2 pW/Hz ^{1/2}		0.13 mm ² (Ø0.4 mm)	10 to 40 °C	Yes

- a. Click on the links to view photos of the items.
- b. Click the icons for details of the housing.
- c. Click on the links to view photos of the detector elements.
- d. When long-term UV light is applied, the product specifications may degrade. For example, the product's UV response may decrease and the dark current may increase. The degree to which the specifications may degrade is based upon factors such as the irradiation level, intensity, and usage time.
- e. The detector active area surface is flush with the front the housing.
- f. We recommend the LDS9 power supply, available separately below.

Part Number	Description	Price	Availability
PDA8A/M	Si Fixed Gain Detector, 320 - 1000 nm, 50 MHz BW, 0.50 mm ² , M4 Taps	\$416.16	Today
PDF10A/M	Si fW Sensitivity Fixed Gain Detector, 320 - 1100 nm, 20 Hz BW, 1.2 mm ² , M4 Taps	\$820.08	Today
PDA015A/M	Si Fixed Gain Detector, 400 - 1000 nm, 380 MHz BW, 0.018 mm ² , M4 Taps	\$895.00	Today
FPD510-FV	Si Fixed Gain, High Sensitivity PIN Detector, 400 - 1000 nm, 250 MHz BW, 0.13 mm ² , M4 Tap	\$1,470.84	3-5 Days
FPD610-FS-VIS	NEW! Si Fixed Gain, High Sensitivity PIN Detector, 400 - 1000 nm, 600 MHz BW, 0.13 mm ² , M4 Tap	\$1,705.00	Today
PDA10A2	NEW! Si Fixed Gain Detector, 200 - 1100 nm, 150 MHz BW, 0.8 mm ² , Universal 8-32 / M4 Taps	\$309.06	Today
PDA8A	Si Fixed Gain Detector, 320 - 1000 nm, 50 MHz BW, 0.5 mm ² , 8-32 Taps	\$416.16	Today
PDF10A	Si fW Sensitivity Fixed Gain Detector, 320 - 1100 nm, 20 Hz BW, 1.2 mm ² , 8-32 Taps	\$820.08	Lead Time
PDA015A	Si Fixed Gain Detector, 400 - 1000 nm, 380 MHz BW, 0.018 mm ² , 8-32 Taps	\$895.00	Today

[Hide Si Amplified Photodetectors, Switchable Gain](#)

Si Amplified Photodetectors, Switchable Gain

Item # ^a	Housing Features ^b	Wavelength Range	Bandwidth Range	Gain		NEP	Typical Performance Graphs	Active Area (Click Link for Image)	Operating Temperature Range	Power Supply Included
				Hi-Z Load	50 Ω Load					
PDA100A ^c		340 - 1100 nm	DC - 2.4 MHz	1.51 kV/A - 4.75 MV/A ^d	0.75 kV/A - 2.38 MV/A ^d	0.973 - 27 pW/Hz ^{1/2}		100 mm ² (10 mm x 10 mm)	10 to 40 °C	Yes
PDA36A		350 - 1100 nm	DC - 10 MHz	1.51 kV/A - 4.75 MV/A ^d	0.75 kV/A - 2.38 MV/A ^d	0.593 - 29.1 pW/Hz ^{1/2}		13 mm ² (3.6 mm x 3.6 mm)	0 to 40 °C	Yes
FPD310-FV		400 - 1000 nm	1 - 1500 MHz	-	5 x 10 ² - 5 x 10 ⁴ V/W	30.0 pW/Hz ^{1/2}		0.13 mm ² (Ø0.4 mm)	10 to 40 °C	No ^e

- Click on the links to view photos of the items.
- Click the icons for details.
- The bandwidth and detection wavelength was improved in October 2012. PDA100A models purchased prior to that time will have a detection range of 400 - 1100 nm and a bandwidth of 1.5 MHz.
- Switchable with 8 x 10 dB Steps. Bandwidth varies inversely with gain.
- We recommend the LDS9 power supply, available separately below.

Part Number	Description	Price	Availability
PDA100A-EC	Si Switchable Gain Detector, 340 - 1100 nm, 2.4 MHz BW, 100 mm ² , M4 Taps	\$360.06	3-5 Days
PDA36A-EC	Si Switchable Gain Detector, 350 - 1100 nm, 10 MHz BW, 13 mm ² , M4 Taps	\$327.42	Today
FPD310-FV	Si Switchable Gain, High Sensitivity PIN Detector, 400 - 1000 nm, 1 MHz - 1.5 GHz BW, 0.13 mm ² , M4 Tap	\$1,095.48	Lead Time
PDA100A	Si Switchable Gain Detector, 340 - 1100 nm, 2.4 MHz BW, 100 mm ² , 8-32 Taps	\$360.06	Lead Time
PDA36A	Si Switchable Gain Detector, 350 - 1100 nm, 10 MHz BW, 13 mm ² , 8-32 Taps	\$327.42	Today

[Hide PDA Power Supply Cable](#)

PDA Power Supply Cable

The PDA-C-72 power cord is offered for the PDA line of amplified photodetectors when using with a power supply other than the one included with the detector. The cord has tinned leads on one end and a PDA-compatible 3-pin connector on the other end. It can be used to power the PDA series of amplified photodetectors with any power supply that provides a DC voltage. The pin descriptions are shown to the right.

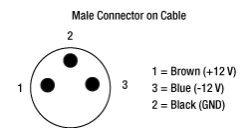

Part Number	Description	Price	Availability
PDA-C-72	72" PDA Power Supply Cable, 3-Pin Connector	\$19.89	Today

[Hide 9 VDC Regulated Power Supply](#)

9 VDC Regulated Power Supply

- ▶ Compatible with Si and InGaAs Amplified High-Sensitivity PIN Detectors
- ▶ 9 VDC Power Output
- ▶ 6 ft (183 cm) Cable with 2.5 mm Phono Plug

Thorlabs' LDS9 is a 9 VDC power supply that is ideal for use with Menlo Systems' Si and InGaAs Amplified High-Sensitivity PIN Detectors. A 6 ft (183 cm) cable with a 2.5 mm phono plug extends from the body of the power supply for connection to a CPS module. When connecting the power supply, please note the polarity of the supply.

The power supply has a selectable line voltage of 115 or 230 V. A 120 VAC power cable is included with the LDS9. To order this item with a different power cable, please contact tech support.

Part Number	Description	Price	Availability
LDS9	9 VDC Regulated Power Supply, 2.5 mm Phono Plug, 120 VAC	\$85.94	Today

[Hide ±12 VDC Regulated Linear Power Supply](#)

±12 VDC Regulated Linear Power Supply

- ▶ Replacement Power Supply for the PDA and PDF Amplified Photodetectors Sold Above
- ▶ ±12 VDC Power Output
- ▶ Current Limit Enabling Short Circuit and Overload Protection
- ▶ On/Off Switch with LED Indicator
- ▶ Switchable AC Input Voltage (100, 120, or 230 VAC)
- ▶ 2 m (6.6 ft) Cable with LUMBERG RSMV3 Male Connector
- ▶ UL and CE Compliant

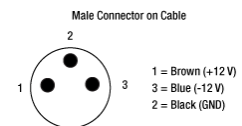

The LDS12B ±12 VDC Regulated Linear Power Supply is intended as a replacement for the supply that comes with our PDA and PDF line of amplified photodetectors sold on this page. The cord has three pins: one for ground, one for +12 V, and one for -12 V (see diagram above). A region-specific power cord is shipped with the LDS12B power supply based on your location. This power supply can also be used with the PDB series of balanced photodetectors, PMM series of photomultiplier modules, APD series of avalanche photodetectors, and the FSAC autocorrelator for femtosecond lasers.

Part Number	Description	Price	Availability
LDS12B	NEW! ±12 VDC Regulated Linear Power Supply, 6 W, 100/120/230 VAC	\$80.33	Today

[Hide Internally SM1-Threaded Fiber Adapters](#)

Internally SM1-Threaded Fiber Adapters

These internally SM1-threaded (1.035"-40) adapters mate connectorized fiber to any of our externally SM1-threaded components, including our photodiode power sensors, our thermal power sensors, and our photodetectors. These adapters are compatible with the housing of the photodetectors on this page.

Item #	S120-SMA	S120-ST	S120-SC	S120-LC
Click Image to Enlarge				
Fiber Connector Type ^a	SMA	ST	SC	LC
Thread	Internal SM1 (1.035"-40)			

a. Other Connector Types Available upon Request





Part Number	Description	Price	Availability
S120-SMA	SMA Fiber Adapter Cap with Internal SM1 (1.035"-40) Thread	\$39.78	Today
S120-ST	ST/PC Fiber Adapter Cap with Internal SM1 (1.035"-40) Thread	\$39.78	Today
S120-SC	SC/PC Fiber Adapter Cap with Internal SM1 (1.035"-40) Thread	\$49.98	Today
S120-LC	LC/PC Fiber Adapter Cap with Internal SM1 (1.035"-40) Thread	\$49.98	Today

[Hide Externally SM1-Threaded Fiber Adapters](#)

Externally SM1-Threaded Fiber Adapters

- ▶ Externally SM1-Threaded (1.035"-40) Disks with FC/PC, FC/APC, SMA, or ST/PC Receptacle
- ▶ Light-Tight When Used with SM1 Lens Tubes
- ▶ Compatible with Many of Our 30 mm Cage Plates and Photodetectors

Each disk has four dimples, two in the front surface and two in the back surface, that allow it to be tightened from either side with the SPW909 or SPW801 spanner wrench. The dimples do not go all the way through the disk so that the adapters can be used in light-tight applications when paired with SM1 lens tubes. Once the adapter is at the desired position, use an SM1RR retaining ring to secure it in place.

Item #	SM1FC	SM1FCA ^a	SM1SMA	SM1ST
Adapter Image (Click the Image to Enlarge)				
Connector Type	FC/PC	FC/APC	SMA	ST/PC
Threading	External SM1 (1.035"-40)			

a. Please note that the SM1FCA has a mechanical angle of only 4°, even though the standard angle for these connectors is 8°. There is a 4° angle of deflection caused by the glass-air interface; when combined with the 4° mechanical angle, the output beam is aligned perpendicular to the adapter face.

Part Number	Description	Price	Availability
SM1FC	FC/PC Fiber Adapter Plate with External SM1 (1.035"-40) Thread	\$29.58	Today
SM1FCA	FC/APC Fiber Adapter Plate with External SM1 (1.035"-40) Thread	\$31.37	Today
SM1SMA	SMA Fiber Adapter Plate with External SM1 (1.035"-40) Thread	\$29.58	Today
SM1ST	ST/PC Fiber Adapter Plate with External SM1 (1.035"-40) Thread	\$28.42	Today



OUTPUT
0-10V

POWER IN

THORLABS

www.thorlabs.com

PDA100A

Si Amplified Detector

340 - 1100 nm

CE

PDA100A Responsivity

